

Thyristor Power Regulator

HANYOUNG NUX

TPR-2N (50/70A)

INSTRUCTION MANUAL

Thank you for purchasing HANYOUNG NUX Co.,Ltd. product.
Please check whether the product you purchased is the exactly same as you ordered. Before using this product, please read instruction manual carefully.



HEAD OFFICE 1381-3, Juan-Dong, Nam-Gu Incheon, Korea
TEL: (82-32)876-4697 FAX: (82-32)876-4696

■ Safety information

Before you use, read safety precautions carefully, and use this product properly. The precautions described in this manual contain important contents related with safety; therefore, please follow the instructions accordingly. The precautions are composed of DANGER, WARNING and CAUTION.

⚠ DANGER

To prevent electric shock while it is running, put to earth with the fixed screw of the unit and do not touch the radiator panel since it is very hot. Do not touch or contact the input/output terminals because they cause electric shock.

⚠ WARNING

- If this product is used with the machinery which may be caused human injury or serious property damage then use it after surely installing the protection equipment for two or three times.
- To prevent deflection or malfunction of this product, supply proper power voltage in accordance with the rating.
- To prevent electric shock or malfunction of product, do not supply the power until the wiring is completed.
- Do not decompose, modify, revise or repair this product. This may be a cause of malfunction, electric shock or fire.
- Reassemble this product while the power is OFF. Otherwise, it may be a cause of malfunction or electric shock

⚠ CAUTION

- The place of operating this product affect to the its functions and life cycle so that avoid to use it in the following circumstance.
 - A place of having high humidity and not circulating air
 - A place of piling dust or impurity or having high ambient temperature or high vibration
- The contents of this manual may be changed without prior notification.
- Make sure that there is no damage or abnormality of the product during delivery.
- After turning OFF power sources of all instruments, please wire them.
- The Thyristor Power Regulator shall be installed perpendicularly.
- Install exhausting fan in internal and upside of the panel.
- Tighten BOLT of the input and output wire enough.
- Do not use this product at any place with corrosive (especially noxious gas or ammonia) or flammable gas.
- Do not use this product at any place with direct vibration or impact.
- Do not use this product at any place with liquid, oil, medical substances, dust, salt or iron contents. (Use at Pollution level 1 or 2)
- Do not polish this product with substances such as alcohol or benzene.
- Do not use this product at any place with a large inductive difficulty or occurring static electricity or magnetic noise.
- Do not use this product at any place with possible thermal accumulation due to direct sunlight or heat radiation.
- Install this product at place under 2,000m in altitude.
- When the product gets wet, the inspection is essential because there is danger of an electric leakage or fire.
- Do not connect anything to the unused terminals.
- After checking the polarity of terminal, connect wires at the correct position.
- The warranty period for this product including parts is one year if this product is properly used

■ Ratings

Power Supply	110 V a.c, 220 V a.c, 380 V a.c, 480 V a.c	
Operating Frequency	50 Hz, 60 Hz (common)	
Rated Current	50 A, 70 A	
Rated Load	Regular type	Resistance load / inductive load (Select by conversion switch)
	FND type	Resistance load / inductive load (Select by internal parameter)
Control input	Current input	4 - 20 mA d.c
	Voltage input	1 - 5 V a.c, 0 - 10 V a.c, 0 - 5 V d.c (FND)
	Contact input	ON/OFF
	External V.R	External volume (10 k Ω)
Control method	Regular type	Phase control, Cycle control, ON/OFF control (switch selection)
	FND type	Phase control, Cycle control, ON/OFF control (parameter selection)
Starting method	SOFT START / DOWN	
Output adjusting range	Above 95 % of input voltage (when applying max current input)	
Cooling method	50 A(Natural cooling), 70 A (Forced cooling)	
Indicating method	Regular type	Indicate the output by LED
	FND type	Indicate the voltage and state by 7 segments
Insulation Resistance	Min. 100 M Ω (500V d.c Mega standard)	
Output adjusting range	0 - 100 %	
Dielectric Strength	2000 V a.c at 50/60 Hz for 1 minute	
Line noise	Noise by noise simulator (2 kV)	
Operating ambient temperature/humidity	0 - 50 °C (with no freezing), 30 - 85 % R.H.	
Storage temperature	-25 - 70 °C	
Weight	Approximately 2 kg	

■ Dimension and Set-up Method

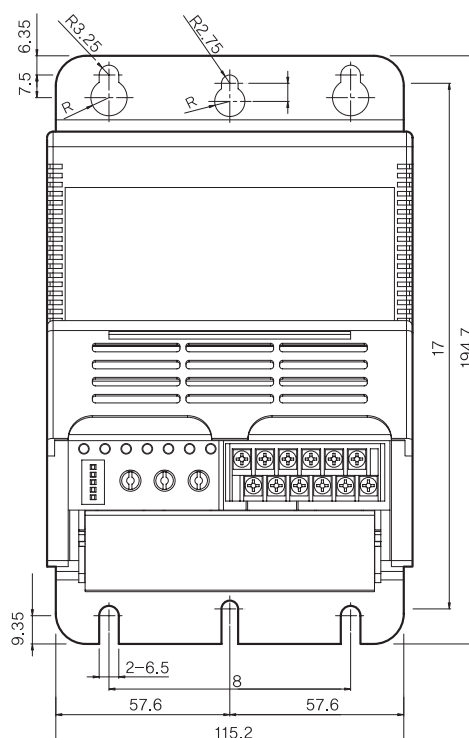

■ Model and Suffix code

Model	Suffix Code	Information
Type	TPR	Power regulator (regular type)
	TPRF	Power regulator (FND indication type)
Phase	2N	Single phase ABS COVER
Power Supply	110	110 V a.c 50/60 Hz
	220	220 V a.c 50/60 Hz
	330	330 V a.c 50/60 Hz
	440	440 V a.c 50/60 Hz
Rated Current	50	50 A
	70	70 A
Option (Only applicable to FND indication type)	N	None
	1	Communication function (RS485/422)

Capacity	Standard	W	H	D
50 A, 70 A		115.2	194.7	131

■ Connection Diagram

■ Terminal arrangement (regular type / FND type)

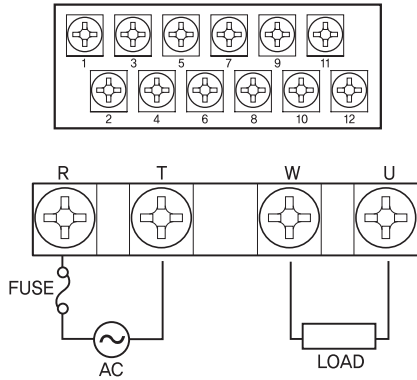

■ Input signal terminal connection diagram (Regular type / FND type)

● 4 - 20 mA (Regular type / FND type)

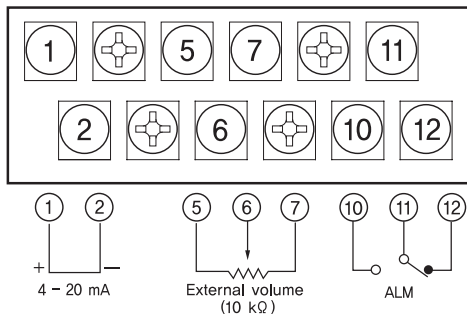

● 1-5 V d.c / 0-10 V d.c (Regular type / FND type)

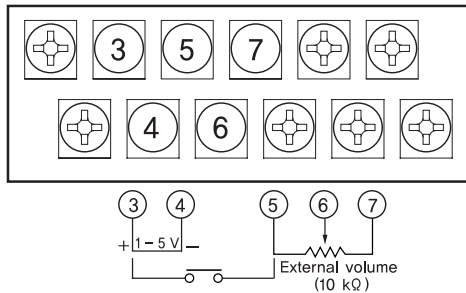

※0 - 10 V regular type : Make to order

● ON/OFF terminal connection diagram (Regular type / FND type)

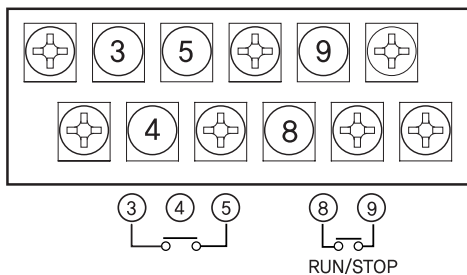

※Set internal jump to 1-5 V with regular type when doing ON / OFF (Initial mode)

● REMOTE input terminal connection diagram (regular type / FND type)

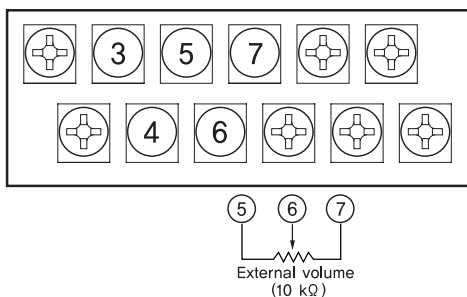

■ Name of each parts

■ Regular type

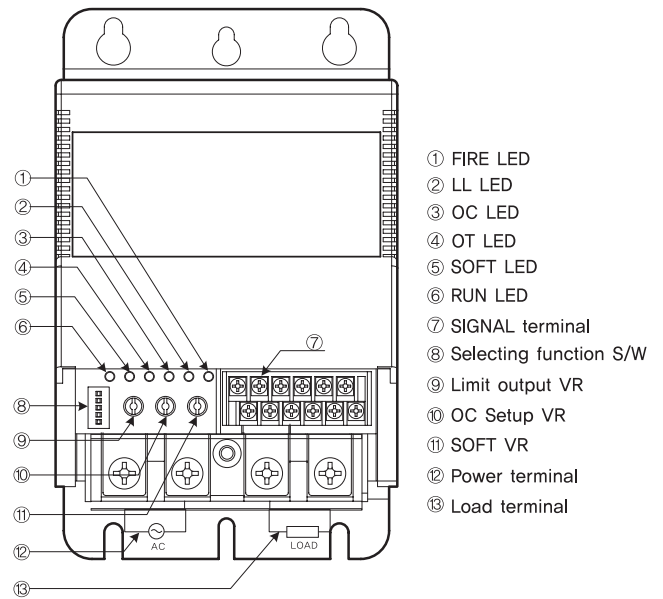

■ FND type

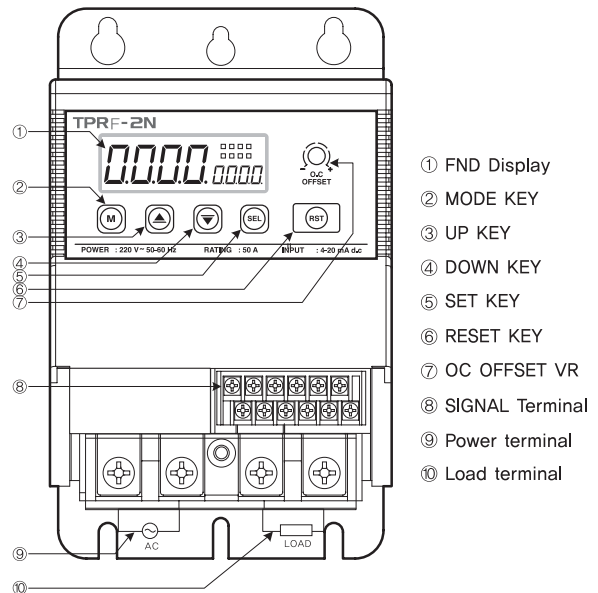

※Please refer to the function explanation of FND TYPE for FND indicating screen

■ Regular type

■ Function explanation

● DIP S/W explanation

S/W NO.	Explanation	
	ON	OFF
1	RESISTOR	Inductance
2	PHASE	CYCLE
3	LOCAL (Use InsideVR)	REMOTE (Use external VR)
4	4 - 20 mA	1 - 5 V (ON/OFF), 0 - 10 V
5	NONE	REMOTE (External VR ONLY)

● Volume explanation

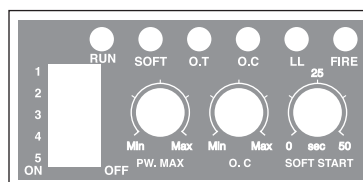

- PW.Max : Change output value within 0 ~ 100 %
- O.C: Set over current alarm value
- SOFT/START: Set soft start time

LED explanation

Symbol	Information
RUN	Lighted when power supplied
SOFT	Lighted when soft start operated
O.T	Lighted when heat sink overheated
O.C	Lighted when over current occurred
LL	Lighted when load disconnection detected
FIRE	Lighted when output become ON

※RUN / STOP

With regular type, all functions temporarily stop and RUN LAMP is lighted

With FND type, all functions temporarily stop and it is in communication standby state.

SOFT-START

When using induction load and etc within capacitive load, turning ON the power switch will supply maximum electric power to the load and this may destroy power device and damage the load. This function prevents above malfunction to happen by making load voltage to increase gradually.

- Set time : 0 ~ 50 Second
- Initial value : 0 Second
- Soft-Start will not operate if soft-start volume is set as the minimum.
- It does not operate within the cycle control
- It is unnecessary within the ON / OFF control mode

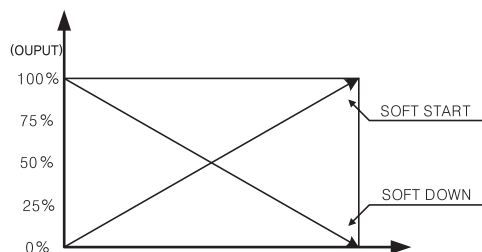

Overheat alarm (O.T)

- If temperature of heat sink goes over 90 degree Celsius, then it will be lighted and alarm output will become ON.
- Setting range: 0 ~ 90
- Initial value: Set maximum value

Over current alarm (O.C)

- When value goes over the set value, then over current LED will be lighted immediately. Also, staying in this condition for more than 0.5 second will output the alarm.
- Setting range: 0 ~ max used current value
- Initial value: Set maximum value
- Only possible to use with phase control. Irms standard ± 1 digit err less than 3 A

Load disconnection alarm (LL)

- Load disconnection detection: When output value is more than the set value and if the load current is less than 1A, alarm will be. Only applicable in phase control.
- Setting range: 0 ~ 100 %
- Initial value: 100 %

Display state of output quantity (FIRE)

- LED will be lighted when output become ON and it will be lighted proportionally depending on output quantity.

Output voltage limitation (PW. Max.)

- This is a function that limits output voltage when using input signal (Ma,V) or external volume (10 k Ω). 0 % of output will be yield if volume is set to the min, 50 % of output will be yield if volume is set to middle of the min and max. And 100 % of output will be yield if volume is set to the max.
- Initial setting is max.
- It is unnecessary within ON / OFF control mode.

Cycle control (ZERO CLOSING CONTROL : DIP S/W2 : OFF)

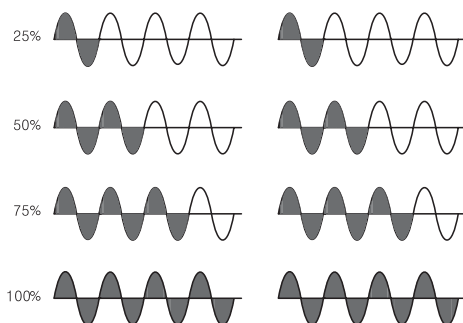

Cycle Control method is a method of making a loaded power as proportionally repeated ON/OFF cycle by a signal of input control in a fixed cycle. The proportionally repeated ON/OFF cycle makes the power applied to the load be regularly. This method is better than Phase Control since this control method makes the loaded power be ON/OFF at the zero point of AC when it is ON/OFF so that there is almost no noise occurrence and it is better for the linearity compared to the Phase Control.

- In Cycle Control, SOFT START function is not operating.

Phase control (PHASE DIP S/W2 : ON)

AC power source has 50/60 Hz frequency and 1/2 cycle of 60 Hz frequency appears a value of 0 ~180 degree in about 8.33 ms Phase Control is a method that after inputting 1/2 cycle into AC power source, it proportionally generates power between 0 ~ 180 degree in 8.33 ms according to the control signal. Also, this method can be fully adjusted according to the wave form of AC so that AC motors and other variety of electronic devices are controlled easily.

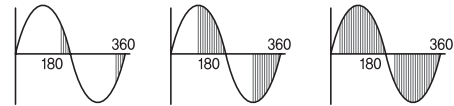

ON/OFF control (Contact control DIP S/W4 : OFF)

ON/OFF Control is automatically set by the wiring terminal. (Refer to the wiring diagram of the input signal terminal.) Not by receiving the input voltage and input current, this method controls the output voltage by receiving contact point signal of relay and others.

Inductance input (DIP S/W1 : OFF)

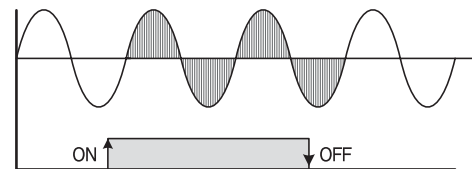

- This is a mode that is used when load contains a lot of inductance components such as coil. Max output value is limited to 50 %.
- [Operation Example]

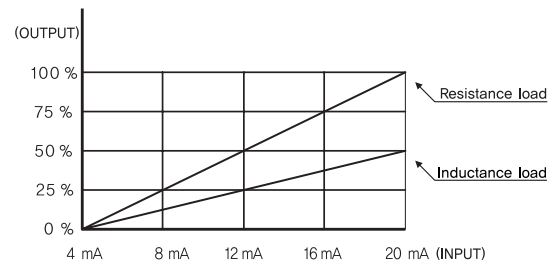

FND type

Function description

- Indicate LED
- FI : Proportional lighting depending on an amount of output
- PR : ON when phase angle resistance load selected
- PL : ON when phase angle induced load selected
- CR : ON when CYCLE control selected
- SF : ON when SOFT START is set
- AL : ON when OC, OT alarm operated
- OC : ON when yield the over current output
- AO : ON when automatically operated

